

PED 90

ISTRUZIONI DI INSTALLAZIONE ASSEMBLY INSTRUCTIONS

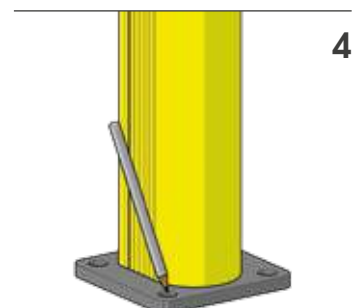
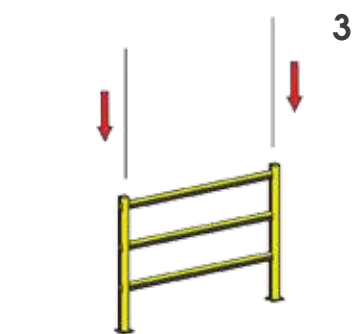
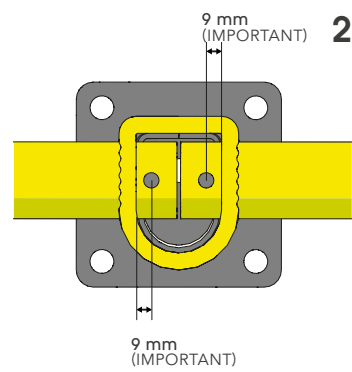
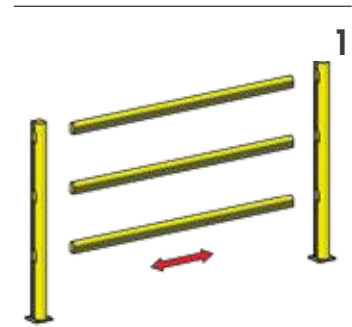

PED 90

ISTRUZIONI DI INSTALLAZIONE
ASSEMBLY INSTRUCTIONS

