

GR 90

ISTRUZIONI DI INSTALLAZIONE
ASSEMBLY INSTRUCTIONS



M16 GALVANISED STEEL

WITH EXPANSION SCREW

Ø16 mm

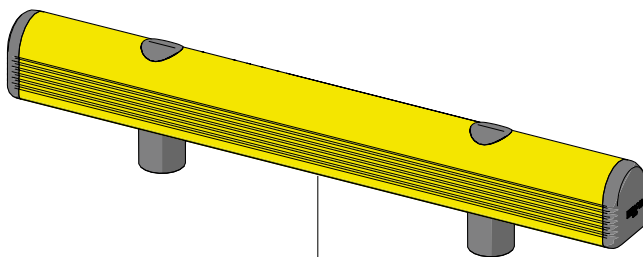
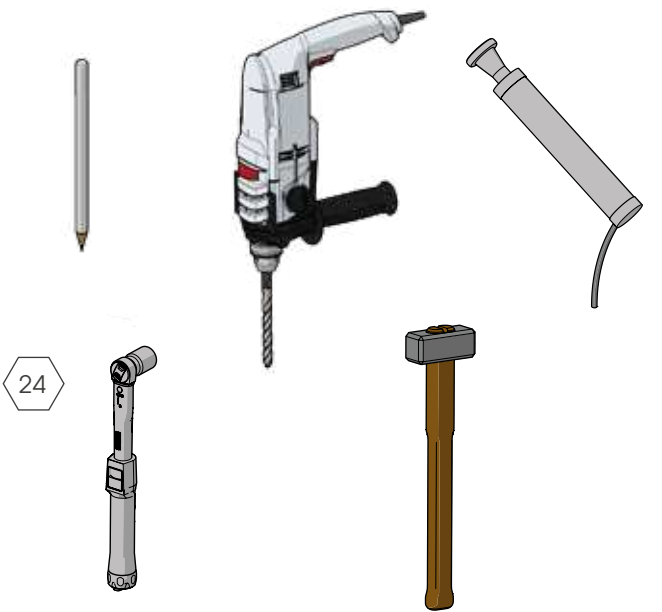

WARNING
The distance of installation depends on speed and weight of vehicle

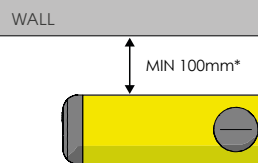

1

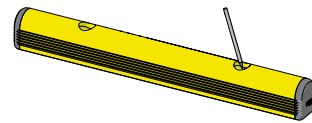

2

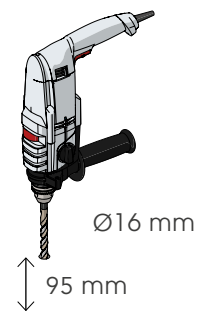

3

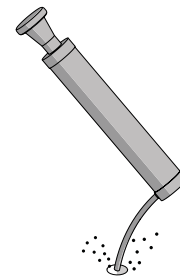

4



GR 90

ISTRUZIONI DI INSTALLAZIONE
ASSEMBLY INSTRUCTIONS



M16 GALVANISED STEEL

WITH EXPANSION SCREW

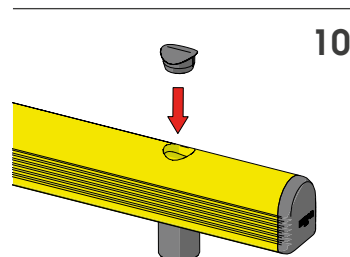
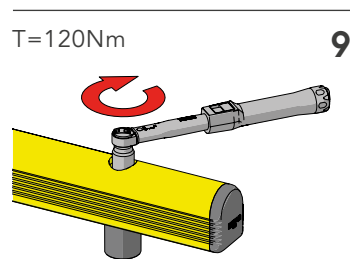
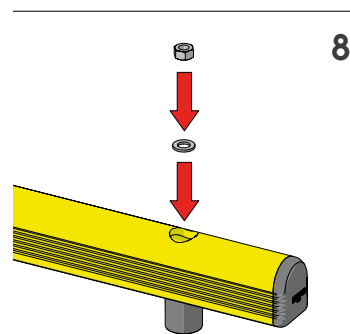
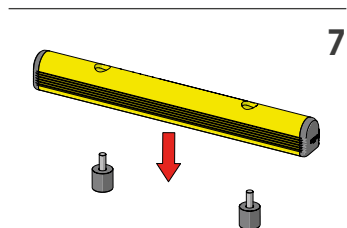
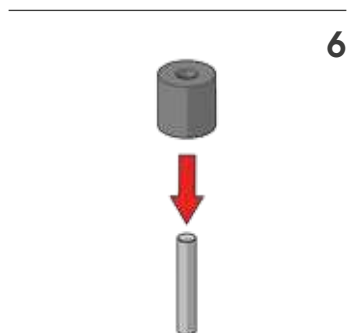
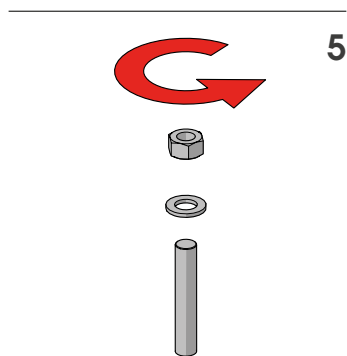

GR 90

ISTRUZIONI DI INSTALLAZIONE
ASSEMBLY INSTRUCTIONS



M16 STAINLESS STEEL



ANCHOR

WITH RESIN

CHEMICAL
ANCHOR

Ø18 mm



24

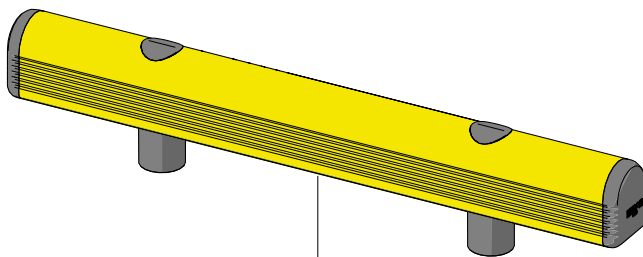

WARNING

The distance of installation depends on speed and weight of vehicle

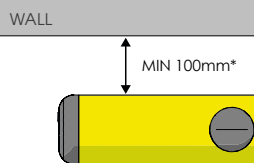

1

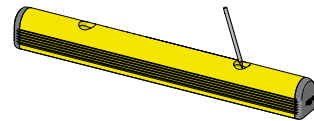

2

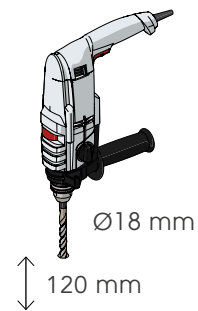

3

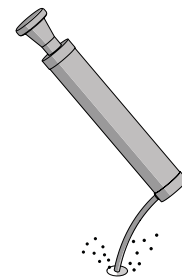

4



GR 90

ISTRUZIONI DI INSTALLAZIONE
ASSEMBLY INSTRUCTIONS



M16 STAINLESS STEEL



ANCHOR

WITH RESIN

